

refleksol[®] 103

- kasseti mõõtmed: **laius 107 mm, kõrgus 117 mm**
- maksimummõõtmed: **laius 4,5 m, kõrgus 4,0 m**
- konstruktsioon saadaval kõikides RAL-toonides
- lai kangavalik
- võimalik kasutada tuulekaitselatte
- elektri- või käsiajam



Refleksol® 103 on süsteem, millele on saadaval hulgaliselt lisavarustust, näiteks tuulekaitsetatid, esteetilised trossid koos pingutitega või täielik pimendussüsteem (mõeldud sisetingimustes).

Külguhikuid **GC30F** ja **GC30FD** saab kasutada konstruktsiooni kandelementidena.



Refleksol® 103 saab kasutada koos tuulekaitsetatiga, mis märgatavalt suurendab kasutusmugavust rasketes ilmastikuoludes (saadaval maksimaalselt 3 m laiusele).

refleksol® 103

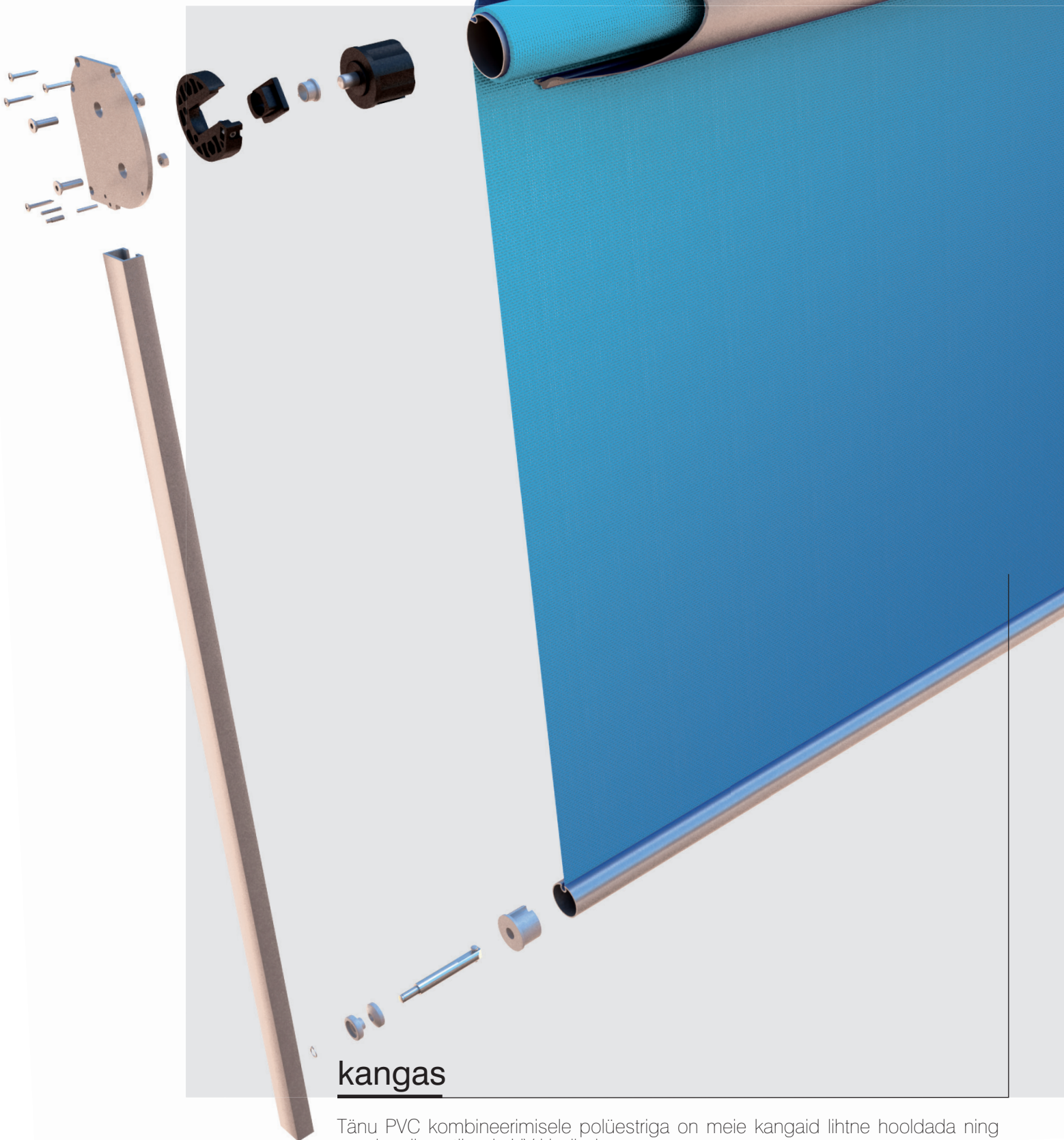

kangas

Tänu PVC kombineerimisele polüestriga on meie kangaid lihtne hooldada ning need on ilmastiku- ja UV-kindlad.



eco  codice®



0338/08

kassett

Kassett on valmistatud ekstrudeeritud alumiiniumist ja ette nähtud paigaldamiseks nii seinale ja lakke kui ka sõrestikfaasadidele.

Moodulpaigalduseks saab kasutada külgjuhikut **GC30FD**.

Külgjuhikuid **GC30F** ja **GC30FD** saab kasutada kasseti kandekonstruktsioonina.

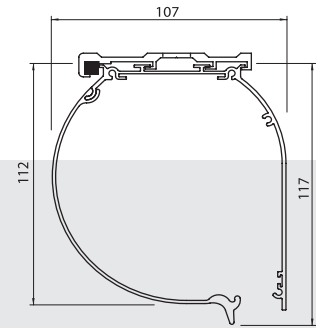

ajam ja automaatika

Pakume juhtivate Euroopa tootjate lahendusi, näiteks täielikku ilmastikuautomaatikat, päikeseandureid, vaikkeid mootoreid, saatja-vastuvõtjaga mootoreid, kaugjuhtimispulte.



külgjuhikud

Sõltuvalt paigalduskohast saab kasutada roostevaba terastrossi, juhikuid **GC30F**, **GC30FD** ja **GC30**, samuti ainult sisetingimustesse mõeldud juhikut **G80**, mis võimaldab täielikku pimendamist.

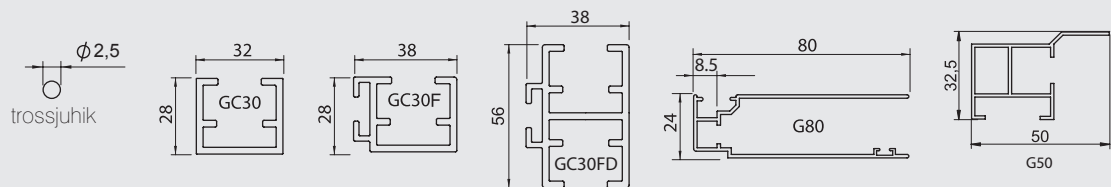

alumine latt

	trossjuhik	GC30	GC30F	GC30FD	G80	G50
∅ 42	✓	✓	✓	✓		
tuulekaitse FG42 (FG42R)		✓	✓	✓		
FG40					✓	✓

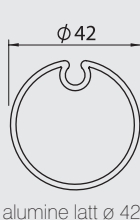

alumine latt ∅ 42



tuulekaitselatt

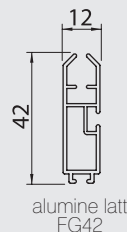

alumine latt FG42

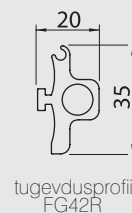

tugevdusprofiil FG42R

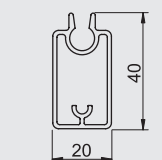

alumine latt FG40